

*Of outstanding importance in*

# TUBERCULOSIS



**T**HE WIDE USE of streptomycin in the treatment of tuberculosis demands that its effectiveness should be matched by flexibility of administration.

For this reason DC(B)L offer streptomycin in a number of forms to meet every individual need.

**'Streptaquaine' Solution**  
(stabilised injection of streptomycin)

**Streptomycin sulphate**

**Dihydrostreptomycin sulphate**

**'Mixtamycin'**  
(streptomycin and dihydrostreptomycin)

**'Mixtamycin' Solution**

**Streptomycin sulphate (stabilised)**

*All products are in 1 and 5 m.u. vials (equivalent to 1 and 5 grammes of base)*



## THE DISTILLERS COMPANY

*(Biochemicals) Limited*

SPEKE, LIVERPOOL 19. Telephone: HUNTS CROSS 1271

Export Enquiries: DEVONSHIRE HOUSE, PICCADILLY, LONDON W.1. Telephone: MAYFAIR 5567

*Owners of the trade marks 'Streptaquaine' and 'Mixtamycin'*

PPR 10/56



**MATBURN  
ELECTRO - SURGICAL  
AND  
SUCTION APPARATUS**

*(MODEL DS16)*

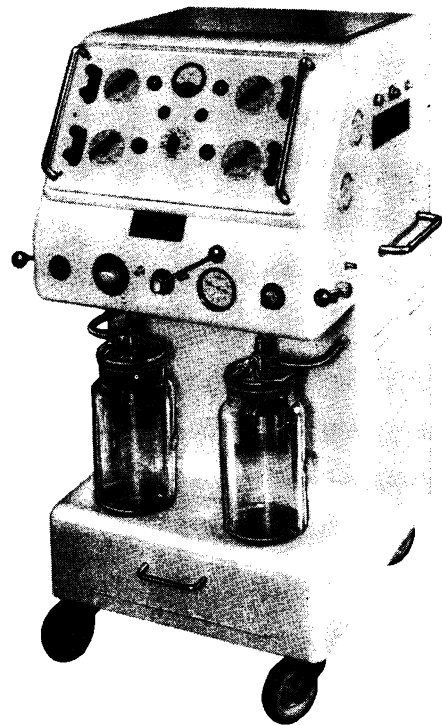

This new apparatus provides a unique combination of all the electrically-operated circuits generally employed in modern surgery. Incorporated within a single unit, facilities are provided for finely controlled diathermy cutting and coagulation, galvano-cautery suitable for light or heavy duty applications and two lighting circuits which can be used simultaneously with diagnostic and endoscopic instruments. The suction unit provides instantaneous displacement of fluids or highly inspissated matter, and is completely noiseless in operation providing very great suction power controllable down to zero. The greatest attention has been paid to Ministry of Health recommendations for electrical safety, a new and important feature being the built-in circuit for testing the continuity of diathermy and other cables. The cabinet, of heavy gauge welded aluminium, is finished stove-enamelled off-white and equipped with a stainless steel top, a compartment for accessories and mounted on 4-inch diameter ball-bearing swivel castors with anti-static tyres. *This apparatus and other equipment for surgical suction is fully described in our brochure which is available upon request.*

**MATBURN LIMITED  
25 RED LION STREET  
LONDON W.C.1**



*Concerning  
a further advance  
in the treatment of  
bucco-pharyngeal  
INFECTIONS*

Dequadin Lozenges containing a new bactericidal and fungicidal substance are rapidly effective against all the common oral pathogens including those resistant to penicillin. They do not contain any antibiotic or anaesthetic substance.

Dequadin Lozenges are indicated in the treatment of Vincent's angina, tonsillitis, sore throat, stomatitis, pyorrhœa, pharyngitis, aphthous ulcers, thrush and glossitis.

They can be used prophylactically in patients exposed to infection especially after tonsillectomy and dental extractions.

By suppressing monilial growths, Dequadin Lozenges prevent the appearance of black tongue and oral thrush. They are also rapidly effective in the treatment of oral thrush including that due to prolonged antibiotic therapy.

# DEQUADIN

## LOZENGES

In tubes of 20 lozenges each containing  
0.25 mg. decamethylene-bis (4-aminoquinaldinium chloride).

CSS/677

ALLEN & HANBURYS LTD · LONDON · E · 2  
TELEPHONE BISHOPSGATE 3201 (20 LINES) · TELEGRAMS GREENBURYS BETH LONDON

# Automatic Exposure Control by Ionisation Current

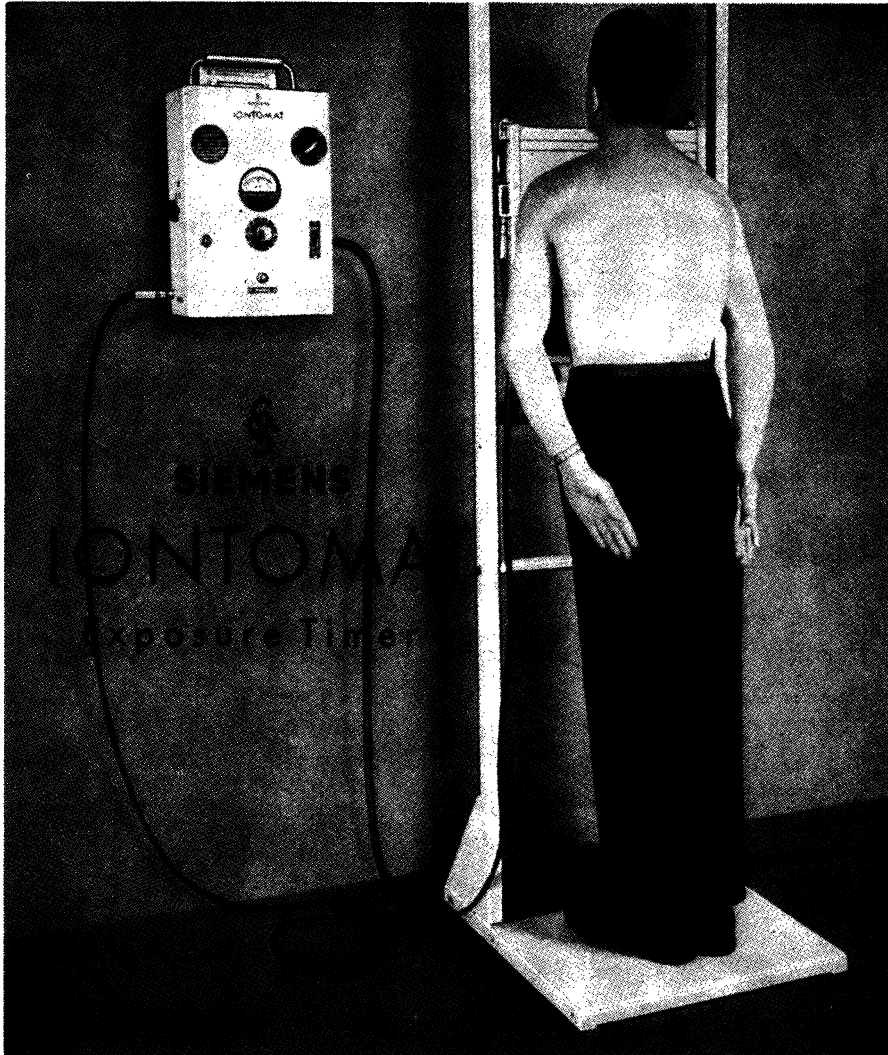

The Iontomat measures the total dose which impinges on the X-ray film and terminates the exposure as soon as the dose for obtaining the optimum contrast is registered.

Completely automatic radiography makes it impossible to get an incorrect exposure; saving in time and money is considerable.

The Iontomat is particularly useful for taking large-size chest pictures as shown in the illustration.

**SIEREX LTD., 241 Tottenham Court Road, London, W.1. Tel.: LANGham 2464**

*Sole distributors for United Kingdom, Eire and British  
Colonies for Siemens Reiniger Werke A.G., Erlangen.*



**THERAPAS** is a modified form of P.A.S. that is more than an alternative.

P.A.S. was originally combined with isoniazid or streptomycin in order to delay the emergence of resistant strains of *M. tuberculosis*. **Therapas does this, too.** It is as effective as P.A.S. for this purpose. Similar in structure to P.A.S., it is converted to it in the body (1). P.A.S. combined with isoniazid or strepto-

mycin is effective against *M. tuberculosis*. **Therapas is more so.** It is not merely an adjunct, but has a therapeutic activity *per se* (2). In combined therapy it is highly effective (3). P.A.S., unfortunately, is poorly tolerated. **Therapas is not so,** and provides a welcome alternative. It has a slightly sweet, not unpleasant taste. Patients who dislike P.A.S. should be tried on Therapas.

1 *J. Pharm. Pharmacol.*, 1953, 5, 849

2 *Schweiz. med. Wschr.*, 1955, 85, 222

3 *Tubercle*, 1955, 36, 209

#### dosage

**Therapas** may be administered in daily doses of 14 G.

#### availability

Individual packets of 3.5 G. in boxes of 100 packets.  
1.0 G. cachets in containers of 100 and 500.  
Bulk Powder in containers of 100 G. and 500 G.



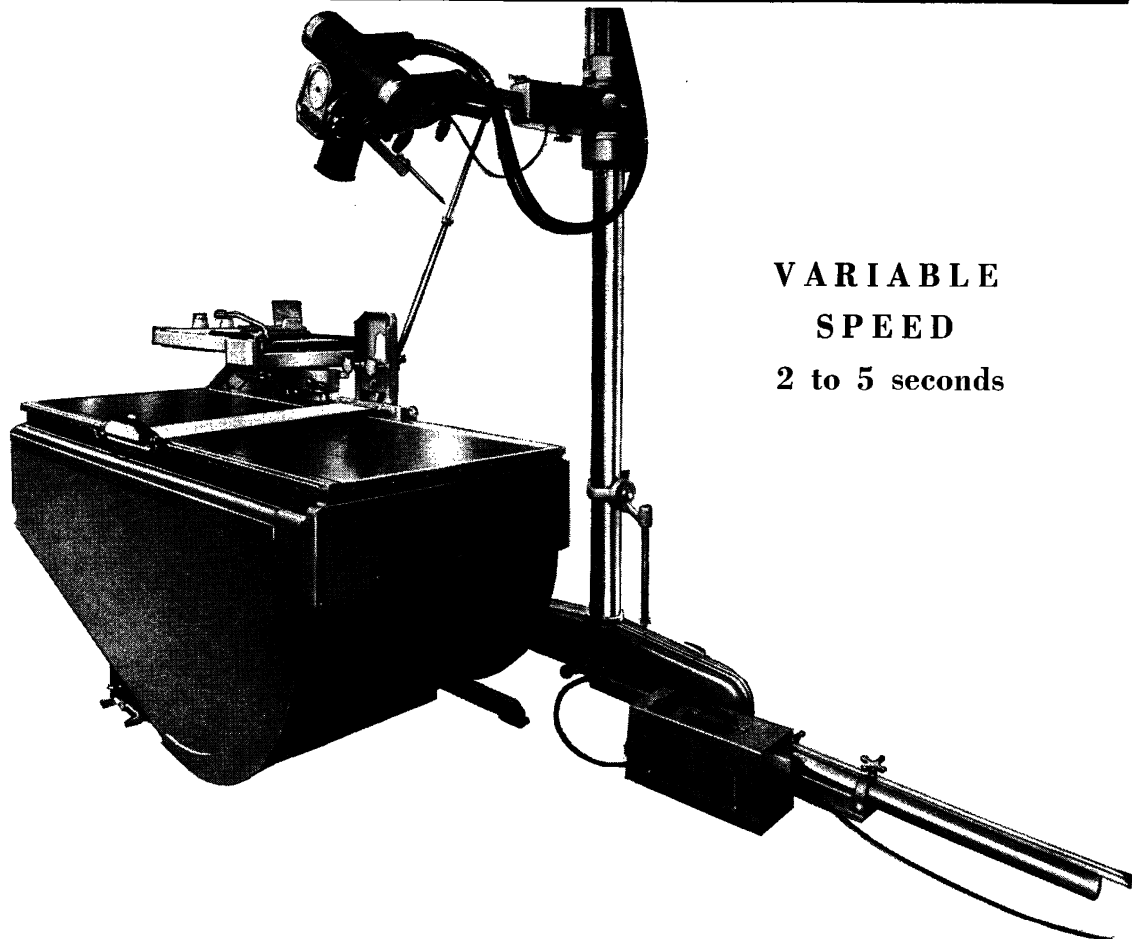

VARIABLE  
SPEED  
2 to 5 seconds

**PNEUMATIC DRIVE** —————  
FOR  
————— **LAYER RADIOGRAPHY**

The illustration above depicts a new type of layer radiography attachment with compressed air drive for the tubestand. The speed of movement can be varied, thus permitting of greater flexibility of exposure technique. Movement is effected by remote control.

Please send for publication No. 101 LRL. for additional details.

**A. E. DEAN & CO.** (X-RAY APPARATUS)  **LTD.**  
G. P. DEAN

PROGRESS WAY · CROYDON · ENGLAND

Telephone: CROydon 0188/9

Midland Agents: Watson & Glover, 2 Easy Row, Birmingham

Telegrams: Frequency, Croydon

Scottish Agent: H. A. West, 41 Watson Crescent, Edinburgh 8

SERVICE FACILITIES AT LEEDS

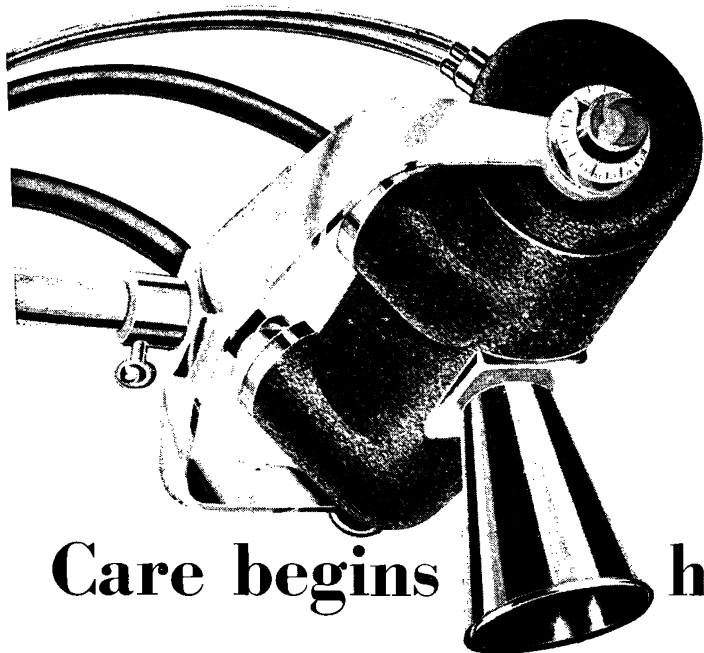

Care begins here

When you consider all the care and attention that goes into the positioning, exposure and processing of a radiograph, it's surely worthwhile taking just as much trouble in choosing the film. By using Ilford X-ray films you can be assured of standards of quality and performance that fully accord with the most stringent diagnostic requirements.

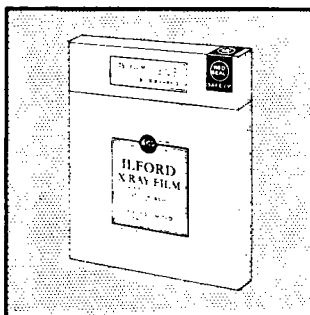

**STANDARD**—the ideal general-purpose film.  
**RED SEAL** — the extra fast, screen-type film.  
**ILFEX**—the fine grain, non-screen film for maximum resolution.

# ILFORD

## X-Ray Films

Standard · Red Seal · Ilfex

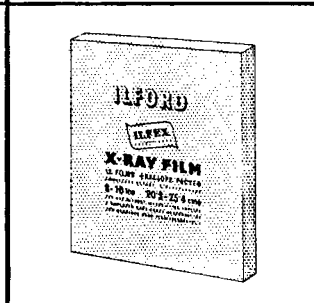

When  
a new  
weapon is  
necessary...

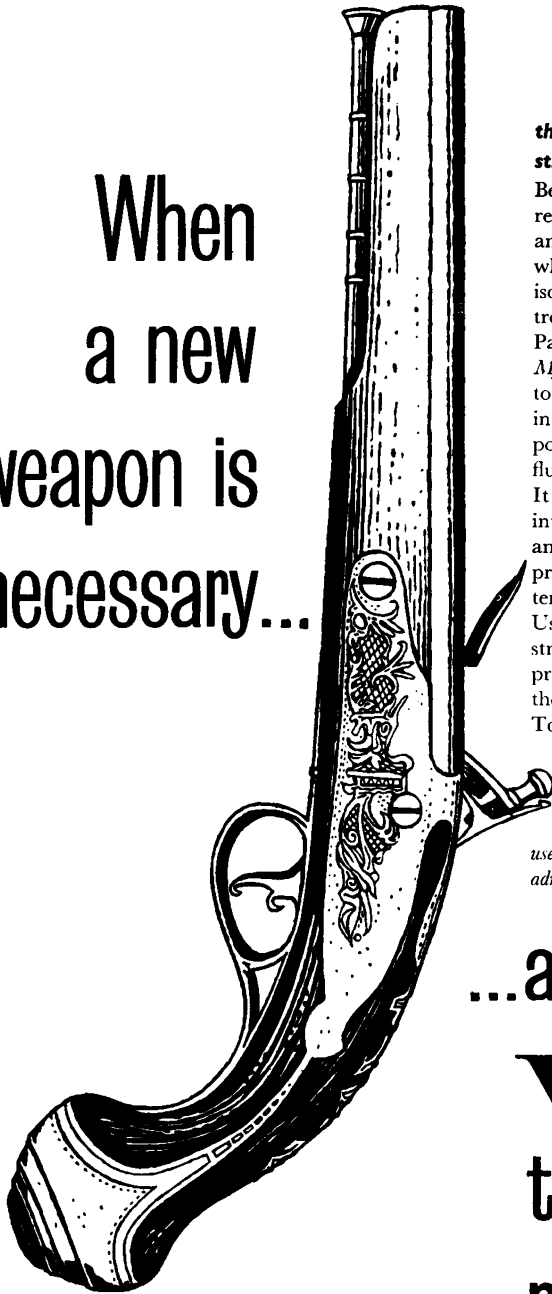

*XVIIIth century flint-  
lock holster pistol,  
English military type.*

**the antibiotic that complements  
streptomycin in tuberculosis**

Because certain tuberculosis patients become resistant or sensitive to streptomycin or isoniazid, and because there is no evidence of cross resistance when it is used with either streptomycin or isoniazid, VIOCIN is of great value as an adjunctive treatment in tubercular chemotherapy. Particularly effective against strains of *Mycobacterium tuberculosis* which have become resistant to streptomycin, VIOCIN when administered intramuscularly is readily absorbed, and a small portion of the total dose is diffused into the spinal fluid and the pleural and peritoneal cavities. It is a relatively safe drug when administered intermittently in recommended dosage, and toxic manifestations have been shown to be predominantly minor, transient, and reversible after termination of therapy.

Used in pulmonary tuberculosis in combination with streptomycin, isoniazid or PAS, VIOCIN has proved capable of exerting a favourable effect on the clinical course of the disease.

Today, VIOCIN commends itself strongly as a powerful new antibiotic weapon necessary in every doctor's medical armoury, for cases resistant to routine measures.

*(Careful laboratory control is necessary when Viocin is used in combination with streptomycin or when it is administered in high dosage over long periods.)*

...add

**VIOCIN\***  
BRAND OF VIOMYCIN SULPHATE

to your  
medical armoury

VIOCIN for intramuscular injection is supplied in sterile powder form as a sulphate, in vials containing the equivalent of 1 G. of pure Viomycin base (Available for supply direct to hospitals)

**Pfizer** WORLD'S LARGEST PRODUCER OF ANTIBIOTICS  
PFIZER LTD · FOLKESTONE · KENT

\* Trade Mark of Chas. Pfizer & Co., Inc.



for symptomatic relief of

**ASTHMA**

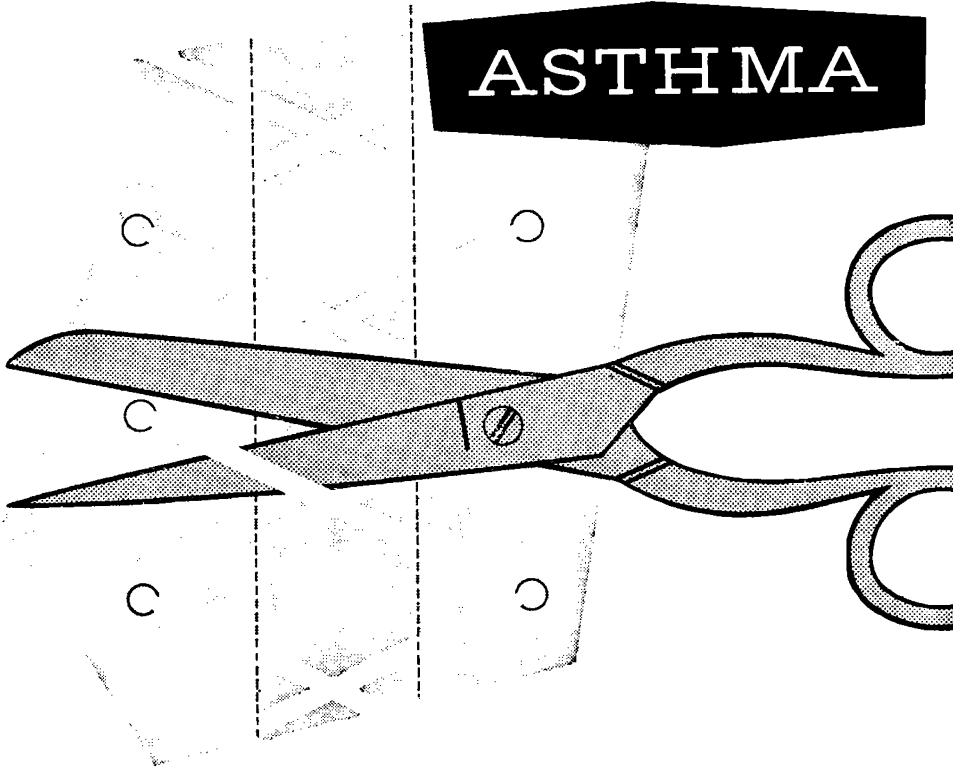

**BENAZMA** is a pleasantly aromatic linctus for the symptomatic relief of asthma. It contains pseudo-ephedrine, which relaxes bronchial muscle in the same way as ephedrine but with a minimum of vasopressor activity; stramonium to help maintain normal cardiac function, and codeine to depress the cough centre.

*Benazma is recommended for the relief of nocturnal cough in asthmatics, and for those patients undergoing specific desensitisation for asthma.*

**EACH DOSE OF 2 FLUID DRACHMS REPRESENTS :**

Pseudo-ephedrine hydrochloride .. ..	1 grain
Ext. Stramon. Liq., B.P. .. ..	1½ minims
Syr. Pruni Serot., B.P. .. ..	1 fluid drachm
Syr. Codeinae Phosph., B.P.C. .. ..	1 fluid drachm

*Bottles of 8, 20 and 80 fluid ounces*



**Benazma**

**(Linctus anti-asthmatic, Bencard)**

**G. L. BENCARD LTD., PARK ROYAL, LONDON, N.W.10**

# Gypsona

TRADE MARK

## has stood the test of time



Soaks more readily than hand-rolled bandages.

Sets firmly in four to five minutes.

Stronger yet less brittle than ordinary plaster.

Casts have porcelain-like surface.

Casts are porous.

Trimmed edges do not crumble and give a neat appearance.

Casts may be bivalved, or cut open

and sprung apart without loss of strength.

Exact number of bandages for a particular cast can be determined beforehand.

Special interlocked woven cloth permits easy moulding.

High plaster content—90% of plaster by weight.

Will keep for a very long time without deterioration when stored in a dry place.

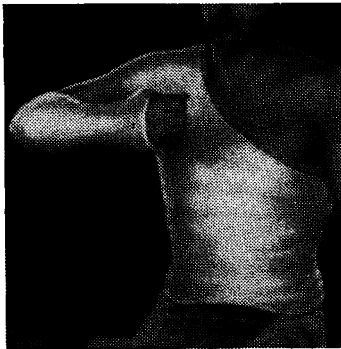

The absence of loose powder and the non-fray edges of the specially-woven leno cloth base of Gypsona bandages provides a distinct advantage over hospital-made bandages.

In performance, the superiority of Gypsona is even more marked. The high plaster content is fixed to the fabric by a special process, and there is a negligible loss of plaster when the bandage is soaked. A surprisingly small amount of material will produce a cast which is light, but of great strength.

Gypsona is by far the most economical plaster for the modern functional treatment of fractures.

SMITH & NEPHEW LTD.  WELWYN GARDEN CITY · HERTS.

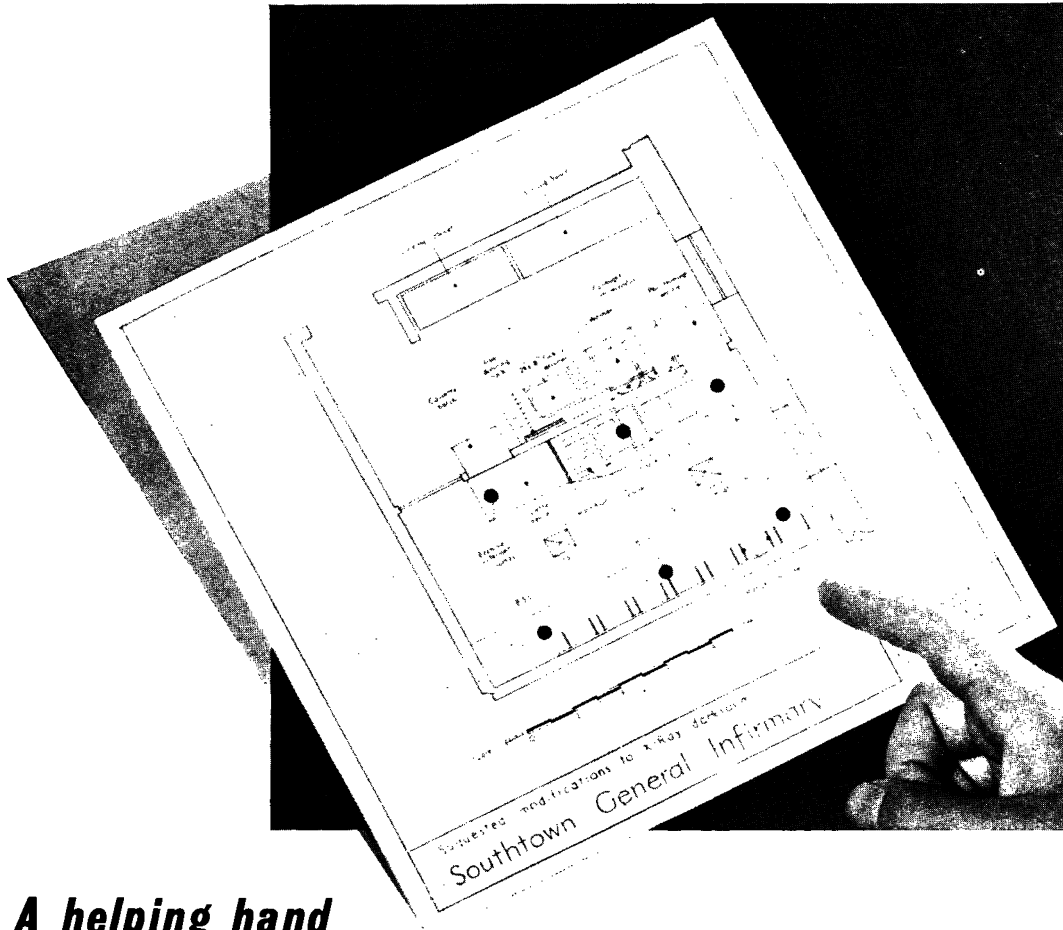

## ***A helping hand with darkroom planning***

**K**NOWING where to turn for the best advice is often half the battle.

Take darkrooms. Planning them is an expert's job. Next time the subject crops up, what a relief to remember you can get all the help you need (as well as all the equipment) from Kodak.

Kodak technicians will co-operate with your architect in drawing up plans. They will suggest the most efficient layout of processing

units, drying cupboards, etc., to suit your particular conditions. They will advise on the important matter of lighting for maximum comfort and safety.

They've done this sort of thing many times, for hospitals large and small. You benefit from a unique fund of photographic and radiographic experience when you consult Kodak. And you get a first-class job, a really *efficient* darkroom, as a result.

# **Kodak**

Kodak Limited, Medical Sales Division, Kodak House, Kingsway, London, W.C.2

**Kodak**  
REGD. TRADE MARK

★ AVAILABLE TO HOSPITALS ONLY

# Tryptar

PURIFIED CRYSTALLINE TRYPSIN

*For Physiologic  
Debridement of Necrotic Tissue,  
Intrapleural Use*

# Tryptar

**A E R O S O L**

*For Bronchial Asthma  
Acute and Chronic Bronchitis,  
Bronchiectasis and Atelectasis*



Write for literature to :

Telephone:  
Hampden Park  
740

**THE ARMOUR LABORATORIES**  
(Armour & Company Ltd.)  
**HAMPDEN PARK, EASTBOURNE, SUSSEX**

Telegrams:  
Armolab  
Eastbourne

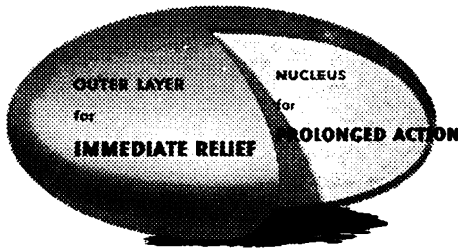

A MODERN  
'TWO-PHASE' ASTHMA THERAPY  
is provided by the double action of

## ISO-BRONCHISAN

... a treatment of outstanding efficiency and convenience for your asthmatic patients.

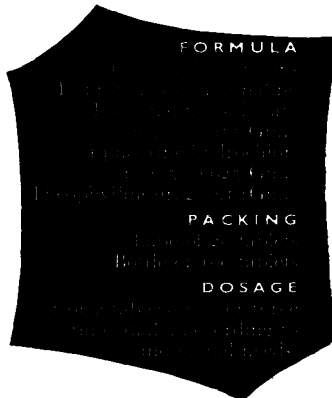

ISO-BRONCHISAN offers a fresh approach to the problem of effective asthma control. The tablets, which are pleasant to take, have a coating of easily dissolved Isopropyl-Nor-Adrenaline, a most potent bronchodilator, which, when absorbed by the sublingual route, results in the immediate relief of symptoms. The rest of the tablet, when swallowed, releases Ephedrine and Theophylline in balanced proportions and these, slowly absorbed along the alimentary tract, ensure long-sustained anti-spasmodic action on the bronchial smooth muscle.



SILTEN LIMITED . SILTEN HOUSE . HATFIELD . HERTS . ENGLAND

# BROMPTON HOSPITAL PATTERN OPERATING TABLE

IMPROVED MODEL

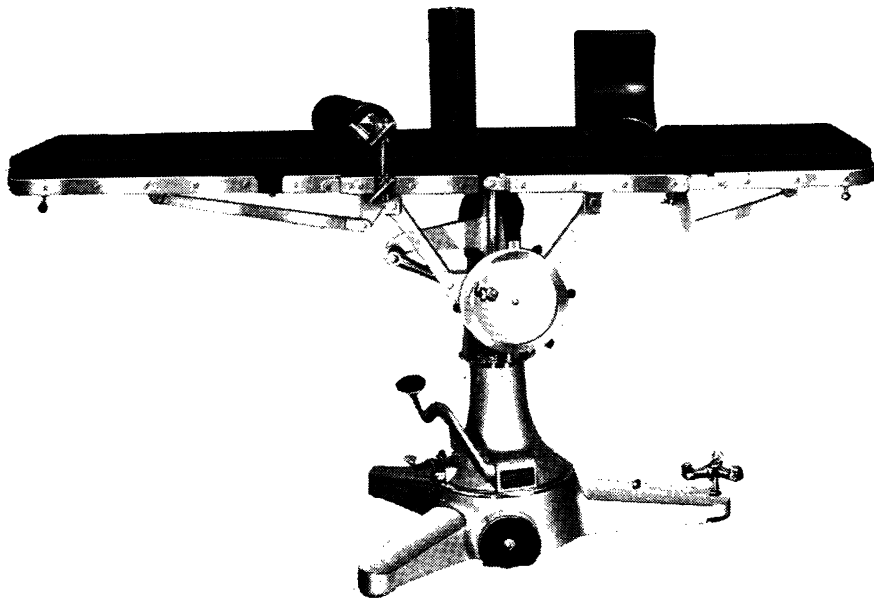

*MADE BY*

**THE G<sub>ENITO-</sub> U<sub>RINARY</sub> MFG. Co. LTD.**

28a, 33 & 34 DEVONSHIRE STREET, LONDON, W.1

*SURGICAL AND OPTICAL  
INSTRUMENT MAKERS*

Telephone:  
WELBECK 2835 (3 lines)

Telegrams:  
CYSTOSCOPE, WESDO, LONDON

# ABSTRACTS OF WORLD MEDICINE

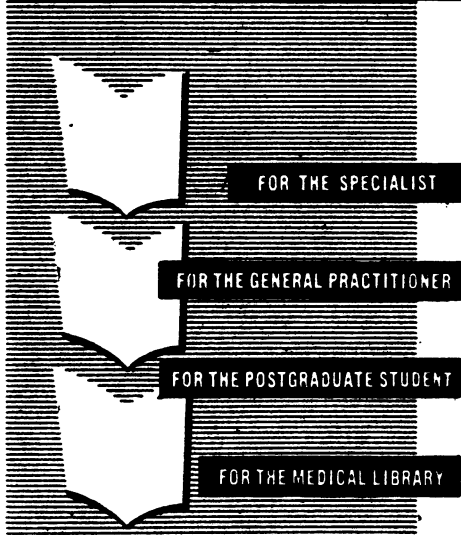

*A monthly journal of informative abstracts—covering every important article published in over 1,600 medical periodicals throughout the world—dealing in each issue with a comprehensive range of subjects.*

- |                            |                          |
|----------------------------|--------------------------|
| Allergy                    | Nutrition and Metabolism |
| Anaesthetics               | Otorhinolaryngology      |
| Bacteriology               | Paediatrics              |
| Cardiovascular Diseases    | Pathology                |
| Chemotherapy               | Pharmacology             |
| Dermatology                | Physical Medicine        |
| Endocrinology              | Psychiatry               |
| Forensic Medicine          | Public Health            |
| Gastroenterology           | Radiology                |
| Haematology                | Respiratory Diseases     |
| History of Medicine        | Rheumatic Diseases       |
| Industrial Medicine        | Tropical Medicine        |
| Infectious Diseases        | Tuberculosis             |
| Medical Genetics           | Urogenital Diseases      |
| Neurology and Neurosurgery | Veneral Diseases         |

A specimen copy may be obtained free from the Publishing Manager

**BRITISH MEDICAL ASSOCIATION**

B.M.A. HOUSE, TAVISTOCK SQUARE, LONDON, W.C.1

**ANNUAL SUBSCRIPTION**  
(12 issues) 24 4s.  
U.S.A. AND CANADA  
\$13.50

## ANY QUESTIONS?

SECOND SERIES ● THIRD SERIES—WITH CUMULATIVE INDEX

*Price 7s. 6d. each (by post 8s.)*

These pocket-size volumes each contain some 200 questions and expert answers from the "Any Questions?" pages of the *British Medical Journal*. Each answer has been chosen for its practical value to doctors in their day-to-day work. Many deal with subjects not covered in the standard text-books.

The third volume has a cumulative index to all the answers appearing in the three books in the series.

*Obtainable from booksellers or by post from Publishing Manager*

**BRITISH MEDICAL ASSOCIATION**

B.M.A. HOUSE, TAVISTOCK SQUARE, LONDON, W.C.1

# A NEW ORAL CHEMOTHERAPEUTIC FOR TUBERCULOSIS

A new chemical compound formed by the combination of INH and PAS in molecular proportions.

DIPASIC IS AVAILABLE FOR INVESTIGATION

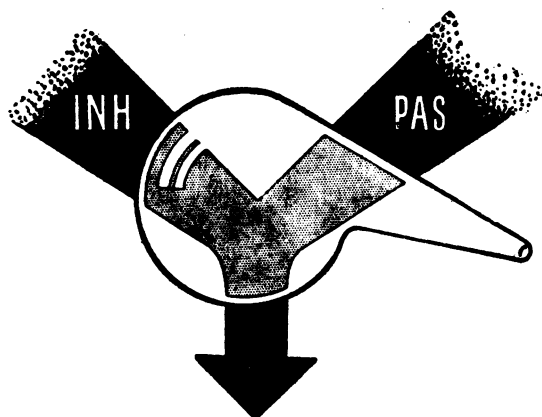

LITERATURE  
ON THERAPY  
AND DOSAGE  
ON REQUEST

# DIPASIC

TABLETS OF 100 mg. OF ISONICOTINIC ACID  
HYDRAZIDE-P-AMINOSALICYLATE



**BENGUE & Co. Ltd.**, MANUFACTURING CHEMISTS  
MOUNT PLEASANT - ALPERTON - WEMBLEY - MIDDLESEX

BENGUE & CO. LTD. MAKE "DIPASIC" AVAILABLE IN THE UNITED KINGDOM BY ARRANGEMENT WITH ED. GEISTLICH  
SONS LTD., WOLHUSEN (SWITZERLAND).